

# APG100 Active Pirani Gauge

Description	Item Number
APG100 - XM NW16	D026-01-000
APG100 - XM NW25	D026-02-000
APG100 - XLC NW16	D026-03-000
APG100 - XLC NW25	D026-04-000

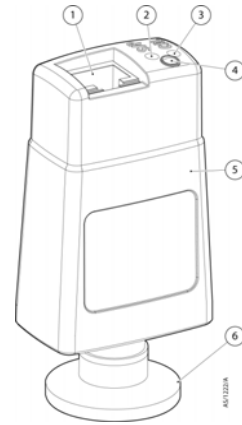

1. Electrical connector
2. Set-point button
3. Cal button
4. Status LED
5. Electronics housing
6. Vacuum flange

Figure 1 - General view of the APG100

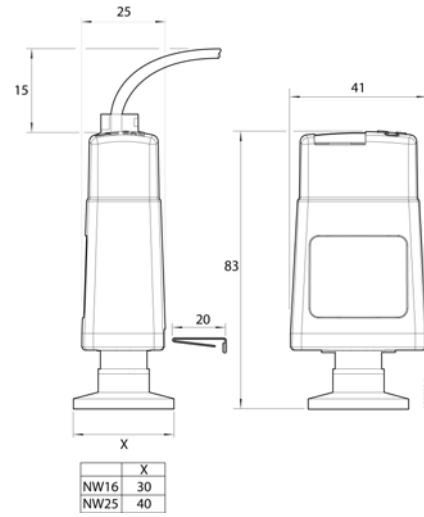

Figure 2 - Dimensions (mm)

## Connect to your own electrical equipment

**CAUTION**  
Do not make any connection to the gauge identification pin (pin 4) as this may cause the gauge to malfunction.

A schematic diagram of the recommended electrical connections to the APG100 is shown in Figure 4. The pins on the electrical connector are used as shown in Table 1. Refer to the Technical Data section for more detailed specifications.

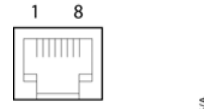

Figure 3 - RJ45 8-way connector

Pin number	Use
1	Electrical supply positive
2	Electrical supply ground (0 V)
3	Pressure measurement output signal
4	Gauge identification
5	Signal ground
6	Set-point output signal
7	Remote calibration input
8	Not connected

Table 1 - Pins on the APG100 electrical connector

Instruction Manual		
	D026-01-880 Iss A	Sep 06

## Introduction

### Scope and definitions

This manual provides installation, operation and maintenance instructions for the BOC Edwards APG100 Active Pirani Gauge. You must use the APG100 as specified in this manual.

Read this manual before you install and operate the APG100. Important safety information is highlighted as **WARNING** and **CAUTION** instructions; you must obey these instructions. The use of **WARNINGS** and **CAUTIONS** is defined below.

**WARNING**  
Warnings are given where failure to observe the instruction could result in injury or death to people.

**CAUTION**  
Cautions are given where failure to observe the instruction could result in damage to the equipment, associated equipment and process.

The following symbols appear on the APG100:

Warning - refer to accompanying documents.

BOC Edwards offer European customers a recycling service.

## Description

The APG100 is a Pirani gauge which measures vacuum pressures in the range 10<sup>-4</sup> mbar to 1000 mbar. It operates using the principle of thermal conductivity in which the rate of heat loss from a heated filament is dependent on the pressure of gas surrounding the filament.

The APG100 is available in two versions: the 'M' version can measure pressure down to 10<sup>-3</sup> mbar and is suitable for general applications; the 'LC' version can measure pressure down to 10<sup>-4</sup> mbar and is also suitable for use in corrosive applications.

A general view of the gauge is shown in Figure 1. The gauge features a detachable tube which allows a replacement to be fitted in the event of contamination or failure of the filament. There are two push-button switches on the top of the gauge. The switch labelled "CAL" is used for atmosphere and vacuum calibration and the switch labelled "S/P" is used to adjust the set-point threshold.

## Technical Data

### Mechanical data

Dimensions Refer to Figure 2

Mass:	
NW16 versions	85 g
NW25 versions	100 g
Internal volume of tube	5 cm <sup>3</sup>
Enclosure rating	IP40

### Performance, operating and storage conditions

Measurement range	
APG100-XM	10 <sup>-3</sup> to 1000 mbar
APG100-XLC	10 <sup>-4</sup> to 1000 mbar
Accuracy	
APG100-XM	typically ± 15 % at < 100 mbar
APG100-XLC	typically ± 15 % at < 10 mbar
Ambient temperature	
Operating	5 to 60 °C
Storage	-30 to +70 °C
Bakeout temperature	150 °C (with electronics housing removed)
Humidity	80 % RH up to 31 °C decreasing linearly to 50 % RH at 40 °C and above
Maximum altitude	3000 m (indoor use only)
Maximum internal pressure	10 bar absolute (9 bar gauge)
Filament temperature	100 °C above ambient

### Electrical data

Electrical supply voltage	15 to 30 V d.c. nominal 13.5 V minimum 32 V maximum
Maximum power consumption	1 W
Max inrush current	150 mA
Electrical connector	FCC68 / RJ45 8-way
Pressure output signal	
Range	1.9 to 9.1 V
Error range	output < 1.8 V or output > 9.2 V
Min load impedance	10 kΩ
Max output current	1 mA
Set-point	
Adjustment range	1.8 to 9.2 V
Hysteresis	500 mV
Max external load rating	30 V d.c., 100 mA
Gauge identification resistance	
APG100-XM	36 kΩ
APG100-XLC	43 kΩ

### Materials exposed to vacuum

Filament	
APG100-XM	Tungsten / Rhenium
APG100-XLC	Platinum / Iridium
Tube	Stainless Steel 316L & 304L
Filter	Stainless Steel 316L
Other	Glass, Ni, NiFe, PTFE (APG100-XLC only)

## Installation

### Unpack and inspect

Remove all packing materials and protective covers. Check the APG100. If the APG100 is damaged, notify your supplier and carrier in writing within three days: state the Item Number of the gauge together with your order number and your suppliers invoice number. Retain all packing materials for inspection. Do not use the APG100 if it is damaged.

If the APG100 is not to be used immediately, replace the protective covers. Store the APG100 in suitable conditions as described in Technical Data section.

### Fit the APG100 to a vacuum system

**WARNING**  
You must use a Co-seal or trapped 'O' ring carrier to connect an APG100 to a vacuum system if the pressure is likely to exceed atmospheric pressure. Standard centring rings are not suitable for use above atmospheric pressure.

**WARNING**  
Do not use the APG100 for safety critical applications. The APG100 is not intended to be fail-safe.

The APG100 can be mounted in any orientation however the gauge tubes are individually factory calibrated in nitrogen whilst vertical. For correct pressure indication in your chosen gauge orientation, the gauge should be recalibrated at atmospheric pressure. BOC Edwards recommends mounting the gauge tube vertical in order to minimise the build up of process particulates and condensable vapours within the gauge.

In accordance with good practice, we recommend that your vacuum system has a secure Earth (ground) connection, and that the tube of the APG100 is electrically connected to the vacuum system.

To connect the APG100 to your vacuum system:

- Use an 'O' ring / centring-ring or Co-Seal to connect an APG100 with an NW16 or NW25 flange to a similar flange on the vacuum system.
- Use a stepped 'O' ring carrier or Co-Seal to connect an APG100 with an NW16 flange to an NW10 flange.

In accordance with good practice, we recommend that your vacuum system has a secure Earth (ground) connection, and that the tube of the APG100 is electrically connected to the vacuum system.

### Connect to a BOC Edwards Controller

The APG100 is compatible with the TIC and ADC digital controllers and the AGD analogue display from BOC Edwards. The controllers will automatically recognise the gauge and display the measured pressure.

To connect to a BOC Edwards controller use a cable which is terminated in suitable connectors. These cables are available from BOC Edwards.

Table 1 - Pins on the APG100 electrical connector

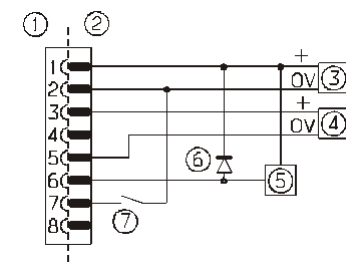

1. APG100 electrical connector socket
2. Cable electrical connector plug
3. Electrical supply
4. Voltmeter
5. d.c. relay (optional)
6. Back EMF suppression diode (optional)
7. Remote calibration switch (optional)

Figure 4 - Recommended electrical connections

Do not connect the electrical supply ground (pin 2) to the signal ground (pin 5). If you do, the APG100 output signal will be inaccurate.

When using the APG100 in an electrically noisy environment you should ensure that your measuring equipment is adequately immune to interference. All BOC Edwards controllers have adequate immunity.

The set-point output on pin 6 is an active low open-collector transistor suitable for driving a d.c. relay or control logic. If you connect a relay you must use a suppression diode, to protect the gauge from transient voltages generated when the relay is switched off, as shown in Figure 4.

Make a connection to pin 7 if you require remote calibration. Momentarily (>50ms) connect pin 7 to pin 2 (ground) to automatically adjust the atmosphere or vacuum reading. Refer to the Maintenance section for the correct procedure.

## Operation

**WARNING**  
Do not use the APG100 to measure the pressure of explosive or flammable gasses or mixtures. The gauge contains a heated filament which normally operates around 100 °C above ambient temperature. The temperature of the filament can be substantially higher under fault conditions.

### Pressure measurement

When the APG100 is connected to a power supply the status LED will turn amber for approximately 2 seconds. The status LED will then turn green if the gauge is operating correctly or red if an error is detected. Refer to the fault finding guide.

If the gauge is connected to a BOC Edwards controller the display will indicate the measured pressure.

If the gauge is connected to a voltmeter convert the voltage (V) to pressure (P) using the following equations:

$$P = 10^{(V-6)}$$

$$P = 10^{(V-6.125)}$$

$$P = 10^{(V-4)}$$

$$P \text{ in mbar}$$

$$P \text{ in Torr}$$

$$P \text{ in Pa}$$

For example if the measured voltage V = 4 V, then the measured pressure P = 1 x 10<sup>-2</sup> mbar. Refer to Figures 5 and 6.

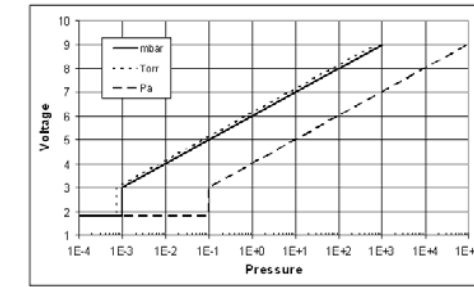

Figure 5 - Voltage to pressure conversion for APG100-XM

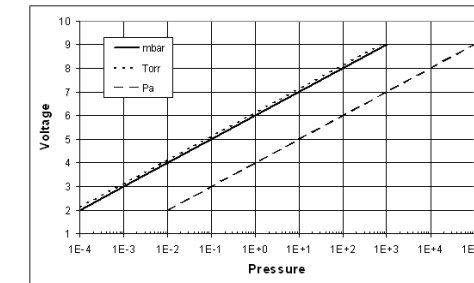

Figure 6 - Voltage to pressure conversion for APG100-XLC

### Gas dependency

The APG100 is calibrated for use in nitrogen, and will read correctly with dry air, oxygen and carbon monoxide. For any other gas type a conversion is required in order to obtain the correct pressure reading. Figures 7 and 8 show the conversion for 6 common gases: nitrogen, argon, carbon dioxide, helium, krypton and neon.

If you are using a BOC Edwards TIC controller, the gas calibration data is built into the controller.

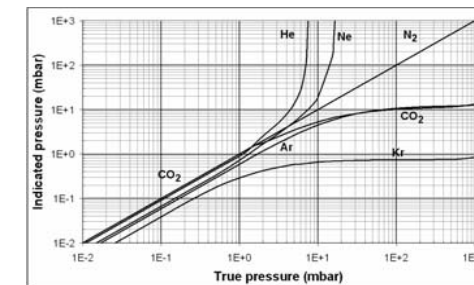

Figure 7 - Gas dependency of APG100-XM

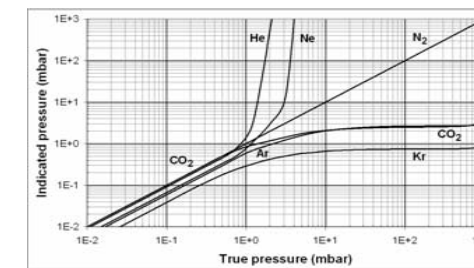

Figure 8 - Gas dependency of APG100-XLC

**PLEASE CONTACT ANY OF THESE COMPANIES FOR DETAILS OF OTHER SALES AND SERVICE CENTRES IN YOUR AREA.**

**EUROPE/ UNITED KINGDOM**  
BOC EDWARDS  
Manor Royal  
Crawley  
West Sussex  
RH10 9LW  
Tel +44 (0)1293 528844  
Fax +44 (0)1293 533453

**CANADA**  
BOC EDWARDS  
5975 Falbourne Street  
Mississauga, Ontario L5R3W6  
Canada  
Tel +1 800 387 4076  
Fax +1 905 501 1225

**ITALY**  
BOC EDWARDS  
Via Carpaccio 35  
20090 Trezzano sul Naviglio  
Milan  
Tel +39 02 48 4471  
Fax +39 02 48 401638

**AMERICAS**  
USA HEADQUARTERS  
BOC EDWARDS  
One Edwards Park  
301 Ballardvale Street  
Wilmington, MA 01887  
Tel +1 978 658 5410  
Fax +1 978 658 7969  
Toll free (USA only) 1 800 848 9800

**GERMANY**  
BOC EDWARDS  
Ammerthalstraße 36  
85551 Kirchheim  
Munich  
Tel +49 89 991 9180  
Fax +49 89 991 91899

**BOC EDWARDS**  
Wilhelm Klein GmbH  
Eckenerstrasse 1  
D-73730 Esslingen  
Postfach 10 03 28  
Tel +49 (0)711/93 18 30-0  
Fax +49 (0)711/93 18 30-3

**FRANCE**  
BOC EDWARDS  
125 Avenue Louis Roche  
92238 Gennevilliers, Cedex  
Paris  
Tel +33 1 47 98 24 01  
Fax +33 1 47 98 44 54

**BELGIUM**  
BOC EDWARDS  
Bergensesteenweg 709  
B1600 Sint-Pieters-Leeuw  
Brussels  
Tel +32 2 363 0030  
Fax +32 2 363 00640

**INDIA**  
BOC EDWARDS  
INDIA HEADQUARTERS  
203 Surya Kiran Building  
19 Kasturba Gandhi Marg  
New Delhi - 110 001  
India  
Tel +91 11 5151 0065  
Fax +91 11 5151 0245

**ISRAEL**  
EDWARDS ISRAEL VACUUM LTD  
5 Habarzel Boulevard  
Gat 2000 Industrial Zone  
Qiryat Gat 82000  
Israel  
Tel +972 8 681 0633  
Fax +972 8 681 0640

**BRAZIL**  
BOC DO BRASIL LTDA  
Rua Bernardo Wrona 222  
02710 São Paulo-SP  
Brazil  
Tel +55 11 3952 5000  
Fax +55 11 3965 2766

**JAPAN**  
HEADQUARTERS  
BOC EDWARDS  
5F Sانشikaikan Building  
1-9-4 Yurakucho Chiyoda-Ku  
Tokyo, 100-0006  
Tel +81 (0)3 6212 6771  
Fax +81 (0)3 6212 6780

**CHINA**  
BOC TRADING  
(SHANGHAI) CO. LTD.  
23 Fu Te Road (N)  
Wai Gao Qiao Free Trade Zone  
Pudong  
Shanghai, 200131  
PRC China  
Tel +86 21 5866 9618  
Fax +86 21 5866 9993

**KOREA**  
HEADQUARTERS  
SONGWON EDWARDS LTD.  
5th FL. Daewoo Engineering Bldg.  
9-3 Sunae-dong  
Kyungki-do  
Korea  
Tel +82 31 716 7070  
Fax + 82 31 738 1001

**TAIWAN, R.O.C.**  
EDWARDS TAIWAN LIMITED  
No. 434 Chung hua Road  
Toufen Town, Miaoli County  
351 Taiwan  
Tel +886 37 611422  
Fax +886 37 611401

**SINGAPORE**  
BOC EDWARDS (ASIA)  
42 Loyang Drive  
Loyang Industrial Estate  
Singapore 508962  
Tel +65 6546 8408  
Fax +65 6546 8407

BOC Edwards is part of BOC Limited. BOC Edwards and the stripe symbol are trade marks of The BOC Group.  
© BOC Edwards 2005

www.bocedwards.com  
info@bocedwards.com

